

Trouver le grafcet à partir d'un schéma

Poinçon

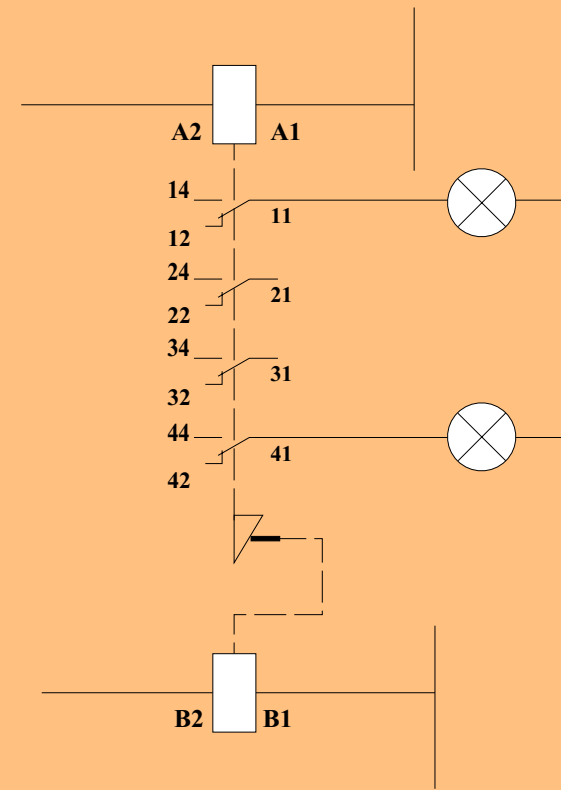

Poinçon

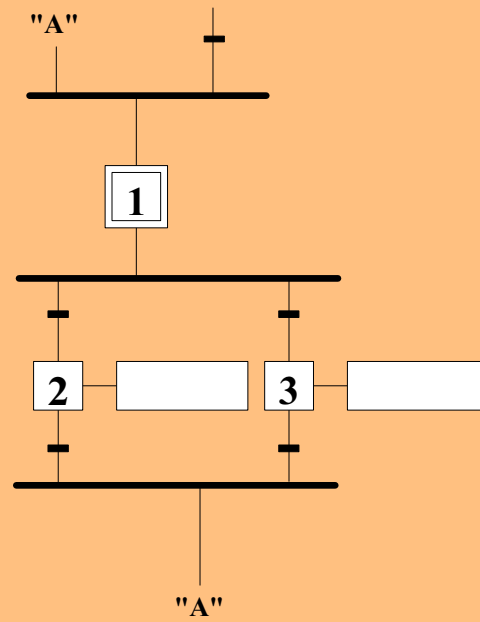
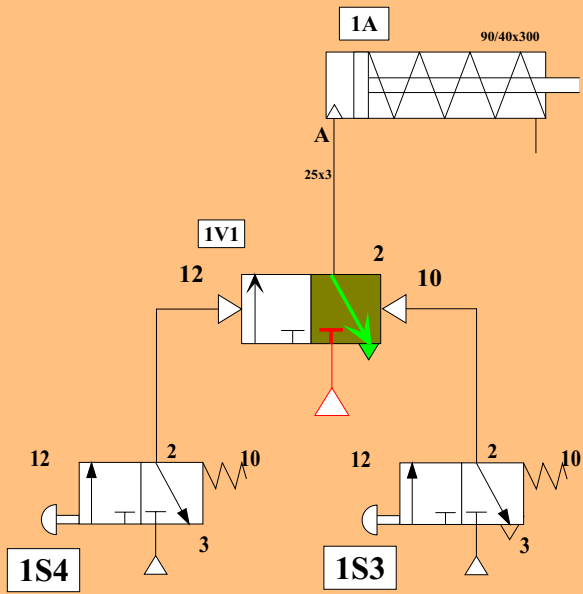
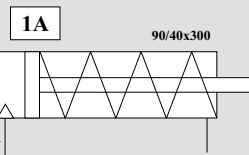

A
25x3

1V1

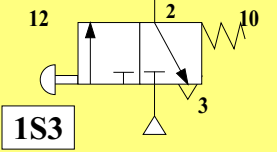
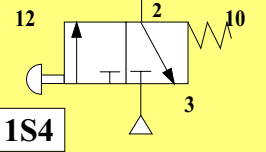
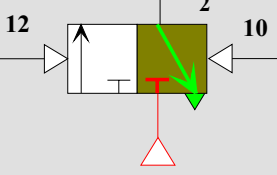

-F1

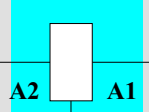
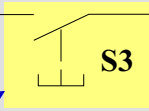

Les commandes

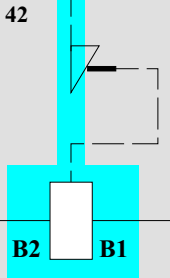
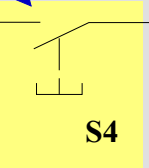

Etude de la PC

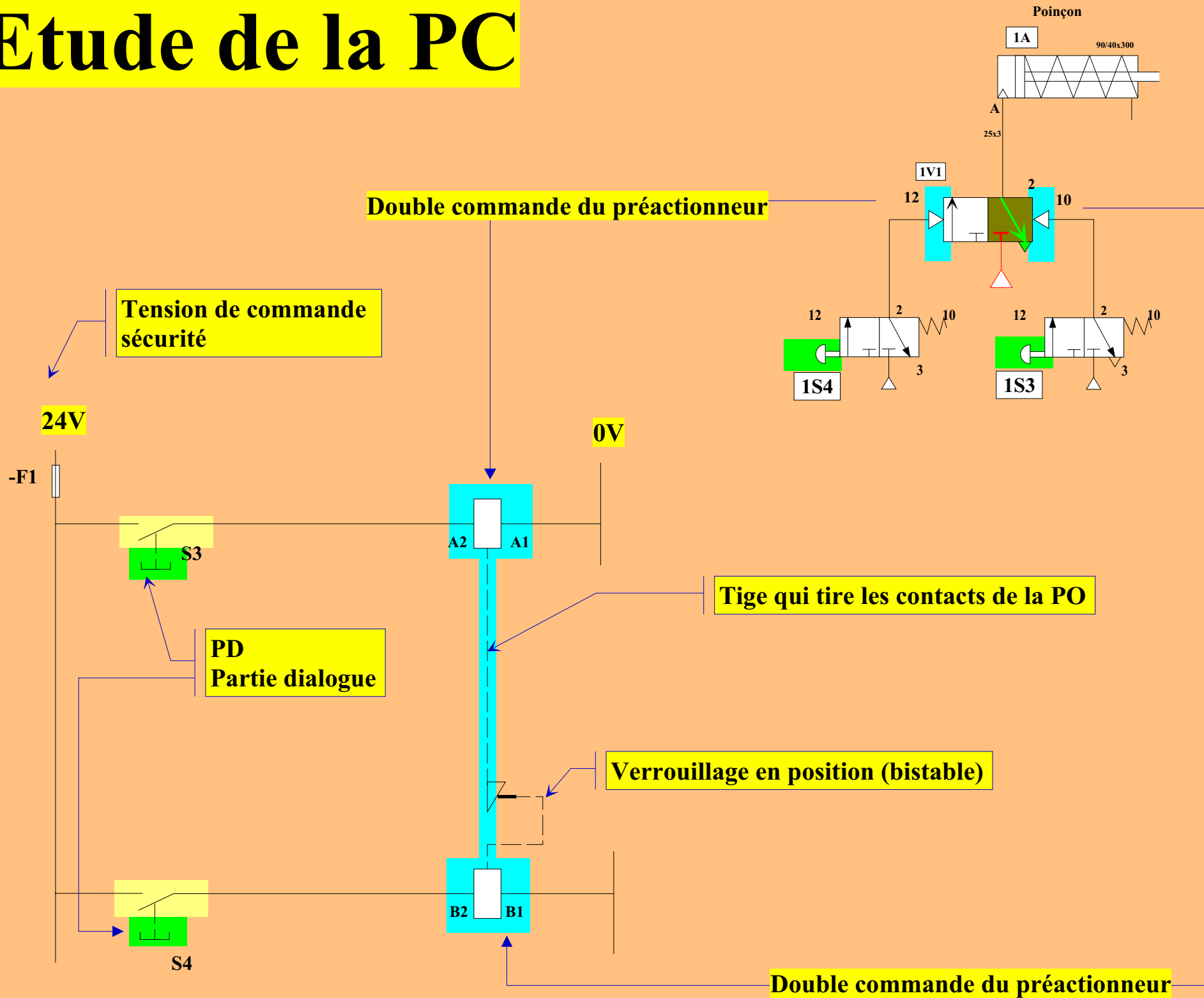

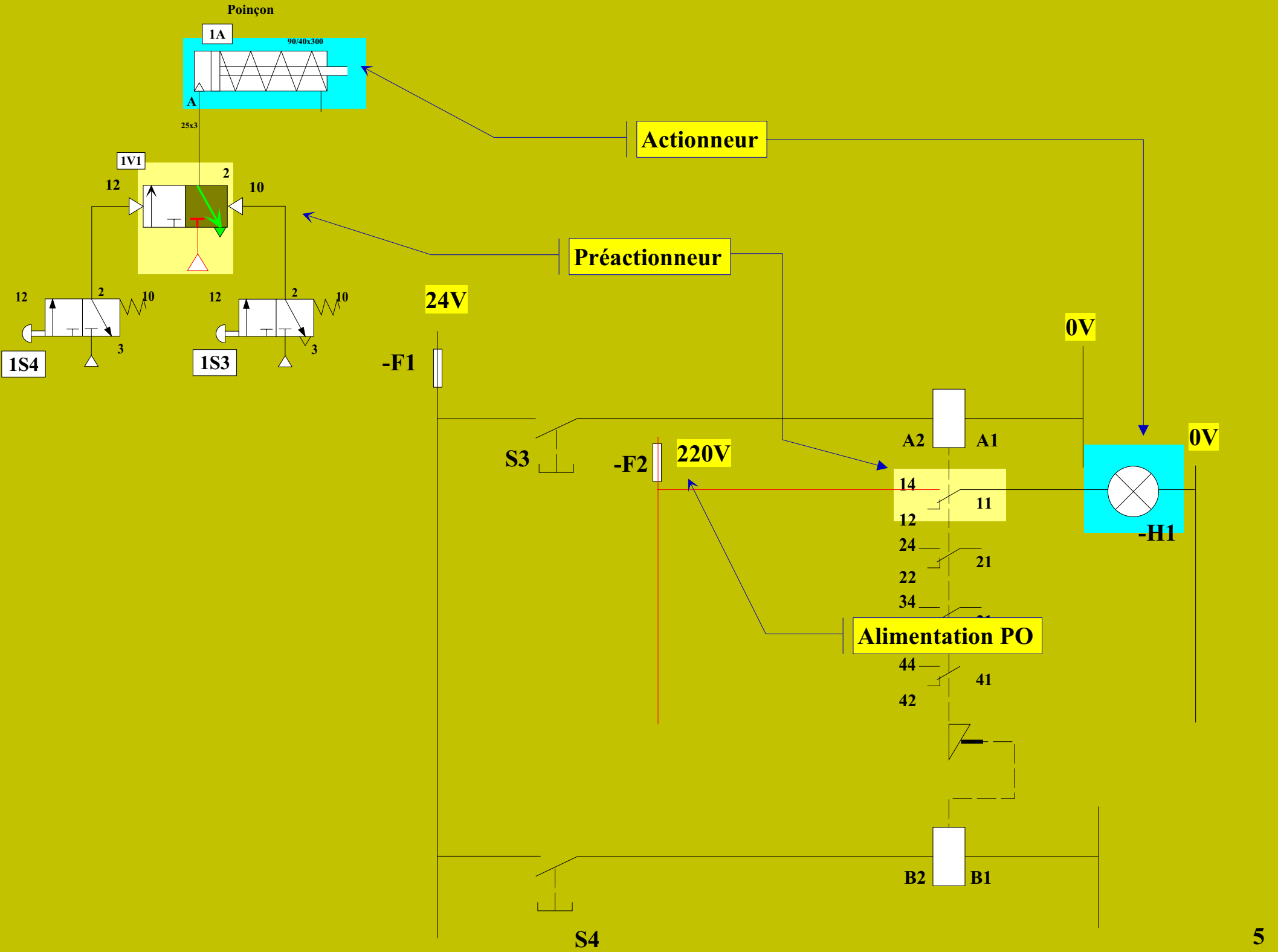

Poinçon

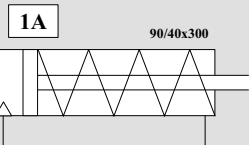

A
25x3

